

WIRELESS BELL PUSH SYSTEM RECEIVER AND TRANSMITTERS

Customer:

General

Project:

General

Date:

24.5.2021

Confidentiality:

Public

CONTENTS

1	GENERAL INFORMATION.....	2
1.1	Scope	2
1.1.1	Receivers	2
1.1.2	Stop buttons	4
1.2	Handling	6
1.3	Cleaning	6
1.4	Storage conditions	7
2	FUNCTIONAL DESCRIPTION.....	8
2.1	Stop buttons	8
2.2	Receiver with constant output (TSF0285).....	8
2.3	Receiver with constant output (TSF0275).....	9
2.4	Receiver with control output (TSF0286).....	9
2.5	Receiver with control output (TSF0276).....	10
3	PROGRAMMING	12
3.1	Product version 1	12
3.2	Product version 2	14
4	INSTALLATION	16
4.1	Stop buttons	16
4.2	Receiver	17
5	DOCUMENT INFORMATION	19

1 GENERAL INFORMATION

1.1 Scope

The scope of this manual covers the receivers listed in chapter 1.1.1 and the stop buttons (transmitters) listed in chapter 1.1.2.

1.1.1 Receivers

Table 1. Receivers 24 V TSF028x

Teknoware Code	Description
TSF0285	Receiver, 4 channels, 868.3 MHz, constant output 
TSF0286	Receiver, 4 channels, 868.3 MHz, signal output (duration 1s) 
TSF0287	Receiver, 4 channels, 902.875 MHz (for North America), signal output (duration 1s), FCC approved similar to TSF0286

Table 2. Receivers 12 V TSF027x

Teknoware Code	Description
TSF0275	Receiver, 4 channels, 868.3 MHz, constant output 
TSF0276	Receiver, 4 channels, 868.3 MHz, signal output (duration 1s) 

Table 3. Receiver technical data TSF028x

Technical data TSF028x	
Input voltage, current	18–32 V _~ ; 800 mA
Fuse	1 A fuse (integrated)
Nominal voltage	24 V
Receiver category	2
Frequency and modulation	868.3 MHz ASK for EU, Australia, Russia, and other countries outside North America. No known restrictions on putting into service in EU countries. 902.875 MHz FSK for North America.
Sensitivity (at 25 °C)	–96 dBm
Maximum load	200 mA / channel
Protection class	IP20
Weight	66 g
Ambient temperature range	–25 °C...+70 °C (operating) –40 °C...+70 °C (no damage)
Operating range	up to 30 m
Connectors	spring clamp connectors, 0.5–1.5 mm ²
Wireless buttons TSF03XX	max 30 pcs / receiver

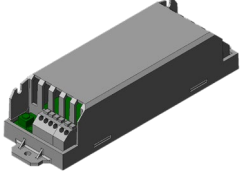
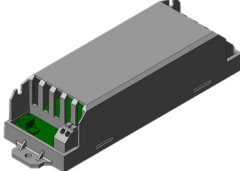

Table 4. Receiver technical data TSF027x

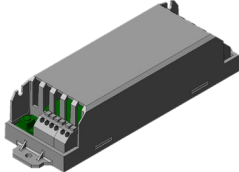
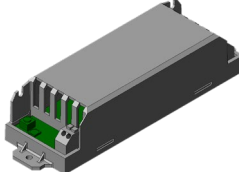
Technical data TSF027x	
Input voltage, current	9–15 V _~ ; 800 mA
Fuse	1 A fuse (integrated)
Nominal voltage	12 V _~
Receiver category	2
Frequency and modulation	868.3 MHz ASK for EU, Australia, Russia, and other countries outside North America. No known restrictions on putting into service in EU countries.

Technical data TSF027x	
Sensitivity (at 25 °C)	-96 dBm
Maximum load	200 mA / channel
Protection class	IP20
Weight	66 g
Ambient temperature range	-25 °C...+70 °C (operating) -40 °C...+70 °C (no damage)
Operating range	up to 30 m
Connectors	spring clamp connectors, 0.5–1.5 mm ²
Wireless buttons TSF03XX	max 30 pcs / receiver

1.1.2 Stop buttons

Table 5. Stop buttons (transmitters)

Button type		Grey body RAL7040		Yellow body RAL1023		Red body RAL3020	
		Pole mounting	Flat surface mounting	Pole mounting	Flat surface mounting	Pole mounting	Flat surface mounting
	Red (RAL3020) stop button with braille	TSF0300	TSF0301	TSF0308	TSF0309	TSF0322	TSF0323
	Grey (RAL7040) stop button with braille	on request	on request	on request	on request	TSF0320	TSF0321
	Blue (RAL5005) stop button with braille	TSF0316	TSF0317	TSF0318	TSF0319	on request	on request





Button type		Grey body RAL7040		Yellow body RAL1023		Red body RAL3020	
		Pole mounting	Flat surface mounting	Pole mounting	Flat surface mounting	Pole mounting	Flat surface mounting
	Blue (RAL5005) stop button with braille for disabled	TSF0302	TSF0303	TSF0310	TSF0311	on request	on request
	Blue (RAL5005) stop button with braille for pram	TSF0304	TSF0305	TSF0312	TSF0313	on request	on request
	Blue (RAL5005) stop button with braille for senior citizens	TSF0306	TSF0307	TSF0314	TSF0315	on request	on request
	Red (RAL3020) stop button with braille, 902.875 MHz for North America	TSF0300U	On request	on request	on request	on request	on request
	Blue (RAL5005) stop button with braille for disabled, 902.875 MHz for North America	TSF0302U	on request	on request	on request	on request	on request

Table 6. Stop button (transmitter) technical data

Technical data	
Output signal	32-bit RF signal
Frequency and modulation	868.3 MHz ASK for EU, Australia, Russia, and other countries outside North America. No known restrictions on putting into service in EU countries
Transmitter power	+5 dBm (3.2 mW)
Weight	37 g (flat surface mounting) 43 g (pole mounting)

Technical data	
Ambient temperature range	-25 °C – +70 °C (operating) -40 °C – +70 °C (no damage)
Operating range	up to 30 m
Installation	with screws through holes Ø 5 mm, max. torque 3 Nm
Pole diameter (pole-mounted buttons)	32–36 mm
Colours, body	Grey RAL7040 Yellow RAL1023 Red RAL3020
Colours, button	Red RAL3020 with white text “STOP” Grey RAL7040 with black text “STOP” Blue RAL5005 with white text “STOP” Blue RAL5005 with white symbol and braille

1.2 Handling

These units contain electronic components. Always handle them with care and avoid inducing any sort of unnecessary mechanical stress or contaminating the units with grease or other chemicals.

1.3 Cleaning

Suitable cleaning agents

The visible surfaces can be cleaned with a mild, neutral detergent. Cleaning agents that are declared suitable for plastics and do not fall into any of the categories listed below in the forbidden substances can be used.

Cleaning agents that are absolutely forbidden

- Cleaners with solvents, thinners, acetone or chlorinated hydrocarbons
- Acids
- Lyes
- Strongly alkaline cleaners
- Abrasive cleaners or abrasive aids.

1.4 Storage conditions

- The units shall not be taken out of the packaging in which they are delivered, nor shall the packaging be altered in a manner which might impair its ability to protect the units from the surrounding environment.
- The units shall be stored in a dry, dust-free environment protected from direct sunlight, rain and other severe weather conditions.
- The ambient temperature must be within the temperature range of $-40\text{ °C} \dots +70\text{ °C}$ ($-40\text{ °F} \dots +158\text{ °F}$) at all times, and the storage area needs to be climate controlled.

Failure to comply with the requirements might result in the warranty becoming void.

2 FUNCTIONAL DESCRIPTION

2.1 Stop buttons

The wireless stop buttons have built-in energy harvesters, which convert the linear motion of pushing the button into energy. Therefore, the buttons do not have a traditional power source of any kind.

With the harvested energy, the buttons are capable of sending an RF signal that includes a 32-bit ID for the button. 32 bits result in billions of possibilities that make it highly improbable to have buttons with the same ID. Due to this feature, the buttons can be programmed for separate channels.

Multiple buttons can be programmed for one channel and one button can be programmed for multiple channels. The programming of the buttons varies slightly depending on the product version: product version 1 buttons have a TEACH mode for programming, while version 2 buttons do not require a separate TEACH mode. The product version is marked on the button's type label, see Figure 1.

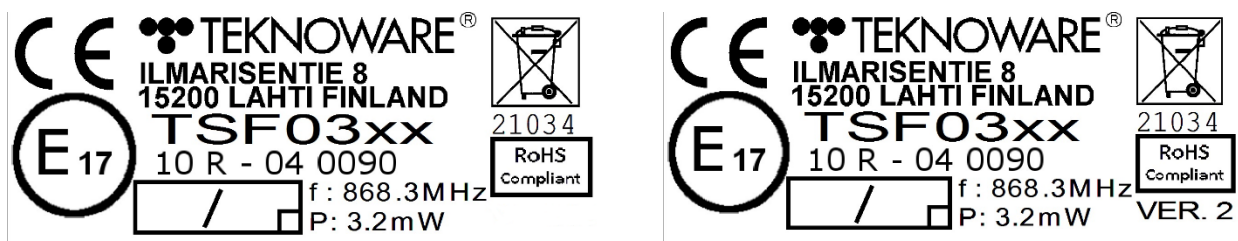

Figure 1. Type labels for version 1 (left) and version 2 (right) buttons: note the VER. 2 mark on the lower right

2.2 Receiver with constant output (TSF0285)

A maximum of 30 buttons can be programmed for one receiver. The receiver has four channels for which the buttons can be programmed. Every channel has an output of 24 VDC, and the maximum current per channel is 200 mA.

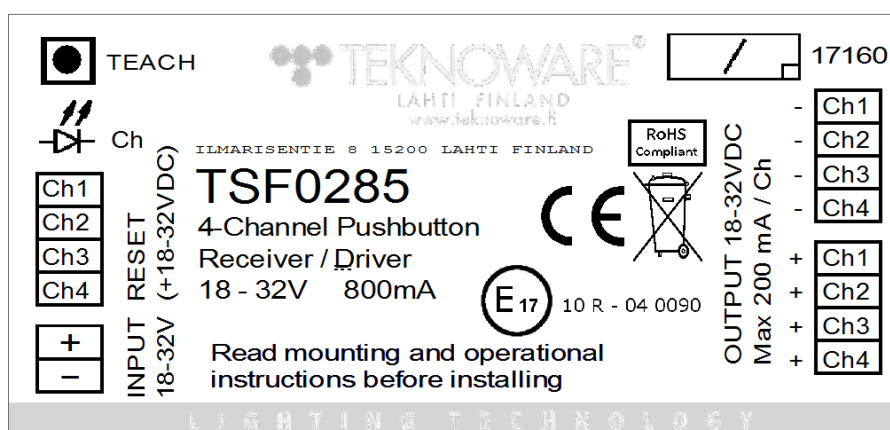

Figure 2. Wiring diagram for TSF0285

Inputs include a supply voltage of 24 VDC and a 24 VDC reset signal for each channel. Reset inputs turn off the output of the channel in question (for example, a door opens and sends a signal that turns off a stop sign).



NOTE!

Once a button is pressed, TSF0285 receiver will switch the output on. To switch it off, it requires a 24 VDC reset input signal.

2.3 Receiver with constant output (TSF0275)

A maximum of 30 buttons can be programmed for one receiver. The receiver has four channels for which the buttons can be programmed. Every channel has an output of 12 VDC, and the maximum current per channel is 200 mA.

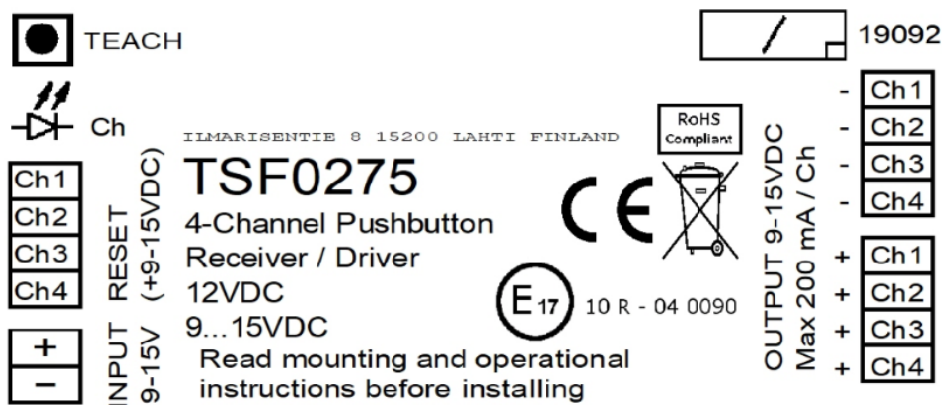

Figure 3. Wiring diagram for TSF0275

Inputs include a supply voltage of 12 VDC and a 12 VDC reset signal for each channel. Reset inputs turn off the output of the channel in question (for example, a door opens and sends a signal that turns off a stop sign).



NOTE!

Once a button is pressed, TSF0275 receiver will switch the output on. To switch it off, it requires a 12 VDC reset input signal.

2.4 Receiver with control output (TSF0286)

A maximum of 30 buttons can be programmed for one receiver. The receiver has four channels for which the buttons can be programmed.

Inputs include supply voltage of 24 VDC. Every channel has an output of 24 VDC, and the maximum current per channel is 200 mA.

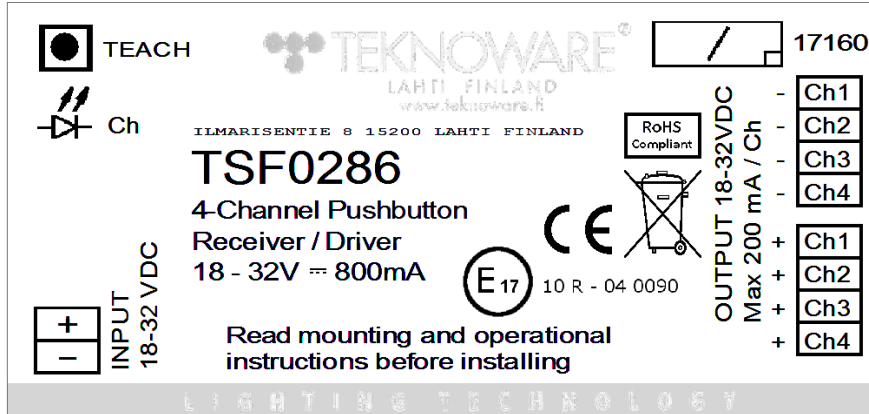

Figure 4. Wiring diagram for TSF0286



NOTE!

Once a button is pressed, TSF0286 receiver will switch the output on for only one second. Therefore, it does not require reset input signals.

2.5 Receiver with control output (TSF0276)

A maximum of 30 buttons can be programmed for one receiver. The receiver has four channels for which the buttons can be programmed.

Inputs include supply voltage of 12 VDC. Every channel has an output of 12 VDC, and the maximum current per channel is 200 mA.

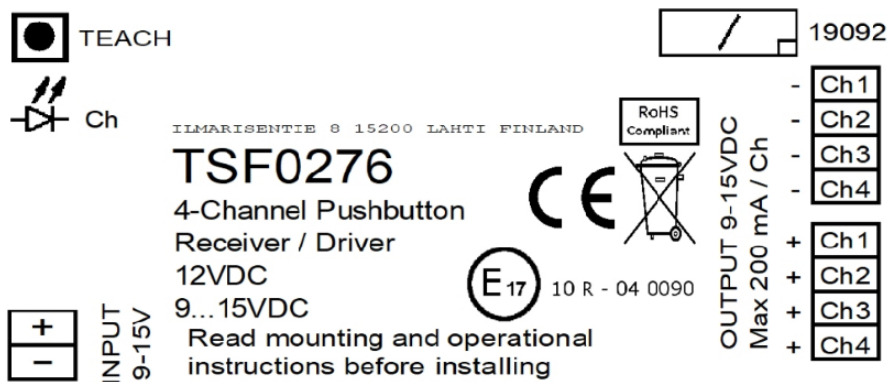

Figure 5. Wiring diagram for TSF0276



NOTE!

Once a button is pressed, TSF0276 receiver will switch the output on for only one second. Therefore, it does not require reset input signals.

3 PROGRAMMING

Before beginning the programming, check the stop button's product version, see Figure 1 in chapter 2.1.



NOTE!

To avoid accidental programming, do not program multiple receivers simultaneously within the range of the RF signals.

3.1 Product version 1

1. Connect a 24 VDC or 12 VDC supply voltage to the receiver. When 24 VDC is used, see Figure 2 or Figure 4 for the correct terminals. When 12 VDC is used, see Figure 3 or Figure 5.
2. Set the buttons to TEACH mode. (See Figure 6.)
3. Programming for Channel 1:
 - a. Press the TEACH button on the receiver for approximately 0.5 seconds so that the LED starts flashing blue.
 - b. Press every button designated for channel 1 while the LED is lit. Pressing a button for a second time, while the LED is lit, undoes the programming.
 - c. Mark the programmed buttons with their channel and set them to ON mode. (See Figure 6.)
4. Programming for Channel 2:
 - a. Press the TEACH button on the receiver for approximately 0.5 seconds so that the LED starts flashing green.
 - b. Press every button designated for channel 2 while the LED is lit. Pressing a button for a second time, while the LED is lit, undoes the programming.
 - c. Mark the programmed buttons with their channel and set them to ON mode. (See Figure 6.)
5. Programming for Channel 3:
 - a. Press the TEACH button on the receiver for approximately 0.5 seconds so that the LED starts flashing red.
 - b. Press every button designated for channel 3 while the LED is lit. Pressing a button for a second time, while the LED is lit, undoes the programming.
 - c. Mark the programmed buttons with their channel and set them to ON mode. (See Figure 6.)
6. Programming for Channel 4:
 - a. Press the TEACH button on the receiver for approximately 0.5 seconds so that the LED starts flashing purple.

- b. Press every button designated for channel 4 while the LED is lit. Pressing a button for a second time, while the LED is lit, undoes the programming.
 - c. Mark the programmed buttons with their channel and set them to ON mode. (See Figure 6.)
7. Press the TEACH button on the receiver once more so that the LED stops flashing. The programming is now complete.
 8. The memory of the receiver can be reset by pressing the reset button on the circuit board, inside the casing (see Figure 7), for longer than 0.5 seconds.

NOTE!

The channels can be programmed in any order while the corresponding LED is flashing.



Channel 1 = BLUE

Channel 2 = GREEN

Channel 3 = RED

Channel 4 = PURPLE

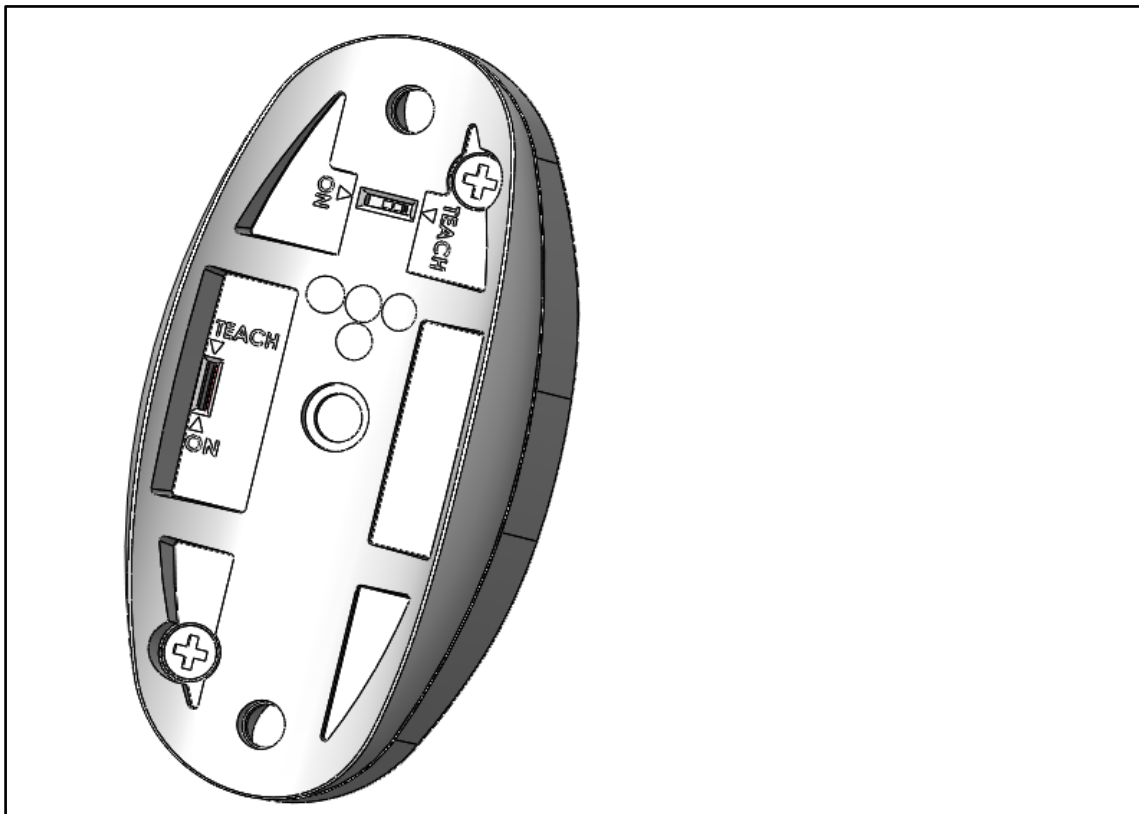

Figure 6. ON / TEACH switch

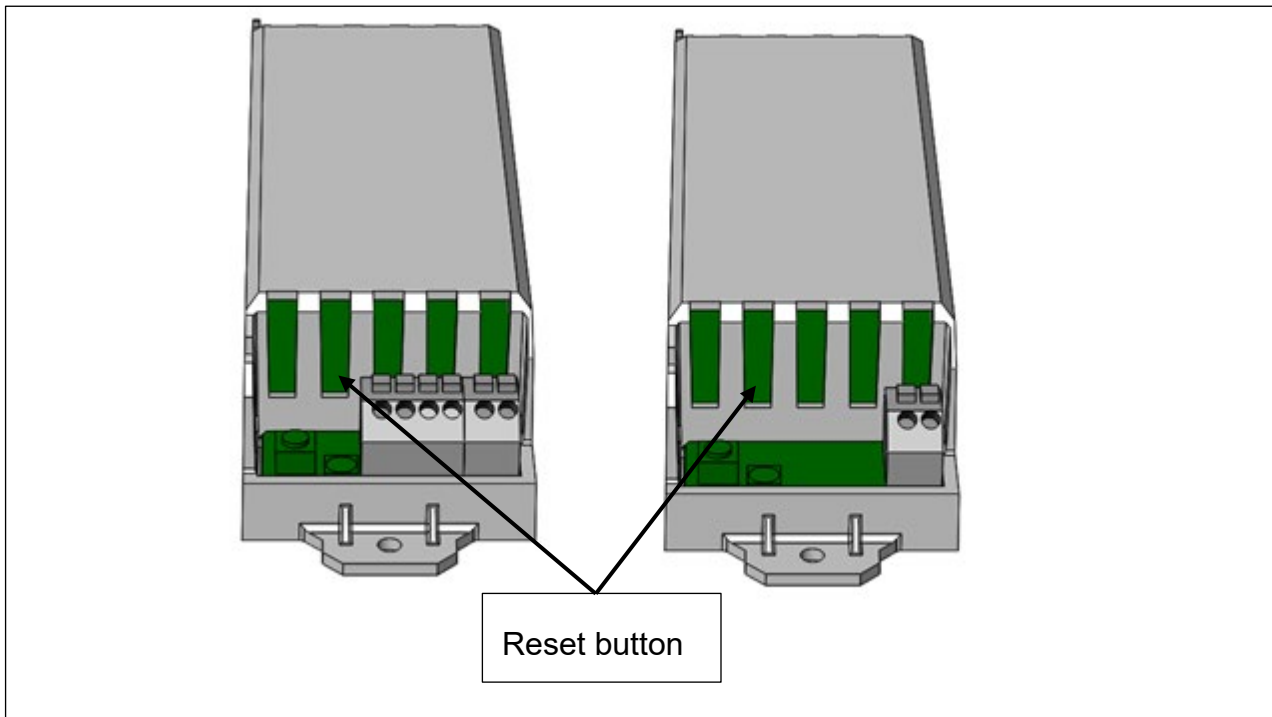

Figure 7. Location of the reset button. Left figure: TSF02075 & TSF0285. Right figure TSF02076 & TSF0286

3.2 Product version 2

1. Connect a 24 VDC or 12 VDC supply voltage to the receiver. When 24 VDC is used, see Figure 2 or Figure 4 for the correct terminals. When 12 VDC is used, see Figure 3 or Figure 5.
2. Programming for Channel 1:
 - a. Press the TEACH button on the receiver for approximately 0.5 seconds so that the LED starts flashing blue.
 - b. Press every button designated for channel 1 while the LED is lit. Pressing a button for a second time, while the LED is lit, undoes the programming.
 - c. Mark the programmed buttons with their channel.
3. Programming for Channel 2:
 - a. Press the TEACH button on the receiver for approximately 0.5 seconds so that the LED starts flashing green.
 - b. Press every button designated for channel 2 while the LED is lit. Pressing a button for a second time, while the LED is lit, undoes the programming.
 - c. Mark the programmed buttons with their channel.
4. Programming for Channel 3:
 - a. Press the TEACH button on the receiver for approximately 0.5 seconds so that the LED starts flashing red.
 - b. Press every button designated for channel 3 while the LED is lit. Pressing a button for a second time, while the LED is lit, undoes the programming.

- c. Mark the programmed buttons with their channel.
5. Programming for Channel 4:
 - a. Press the TEACH button on the receiver for approximately 0.5 seconds so that the LED starts flashing purple.
 - b. Press every button designated for channel 4 while the LED is lit. Pressing a button for a second time, while the LED is lit, undoes the programming.
 - c. Mark the programmed buttons with their channel.
6. Press the TEACH button on the receiver once more so that the LED stops flashing. The programming is now complete.
7. The memory of the receiver can be reset by pressing the reset button on the circuit board, inside the casing (see Figure 7), for longer than 0.5 seconds.

4 INSTALLATION

4.1 Stop buttons



NOTE!

Product version 1 buttons must be programmed before performing the installation.

See Figure 8 and Figure 9 for dimensions for the pole mounted and flat surface stop buttons. The buttons are mounted with screws through the \varnothing 5 mm holes. The maximum torque for the screws is 3 Nm for both pole mounted and flat surface stop buttons. No wiring is required!

Teknoware recommends the following types of screws to be used in installation:

- Pole mounted stop buttons: Teknoware code QL42130C (PLATE SCREW PAN TX20 4.2x13mm ZN DIN 7981F)
- Flat surface stop buttons: Teknoware code OW319 (MACHINE SCREW PAN TX20 M4x12mm A2-70 ISO 14583)

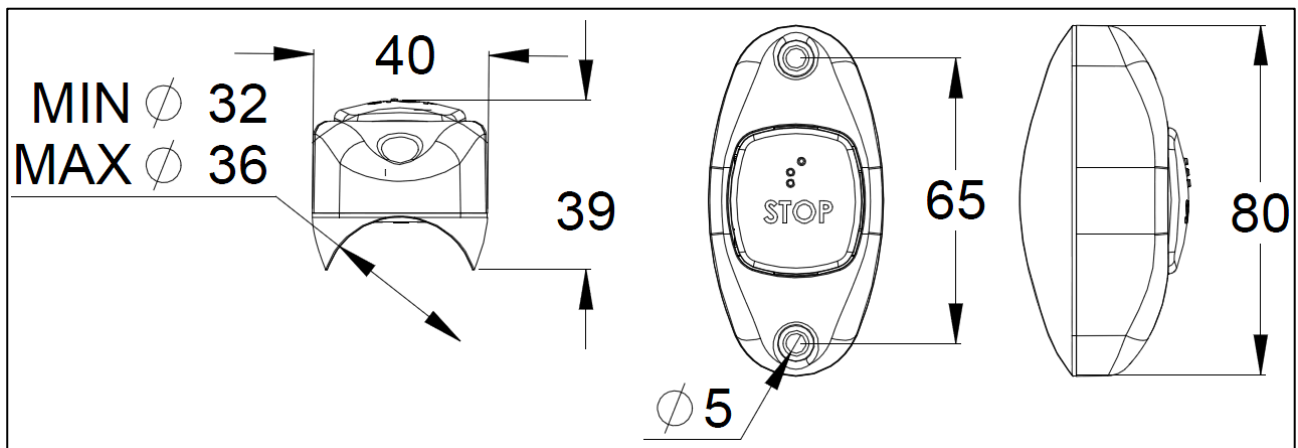

Figure 8. Dimensions of a stop button for pole mounting

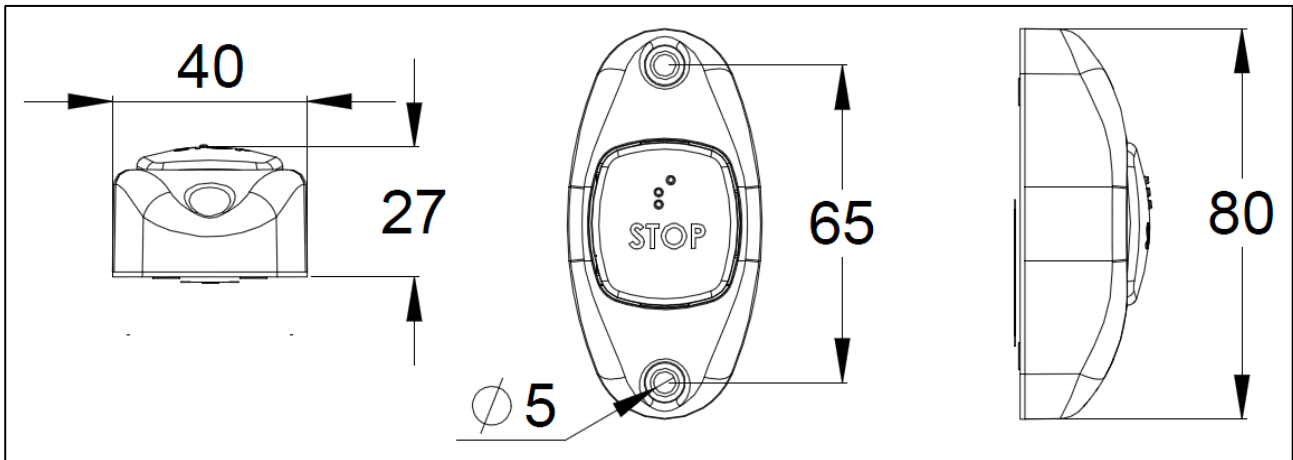

Figure 9. Dimensions of a stop button for flat surfaces

4.2 Receiver



NOTE!

Do not mount the receiver in a location that blocks the RF signals from the buttons.

See Figure 10 for the dimensions of the receivers. The receiver can be mounted with screws through the holes provided on two edges of the unit.

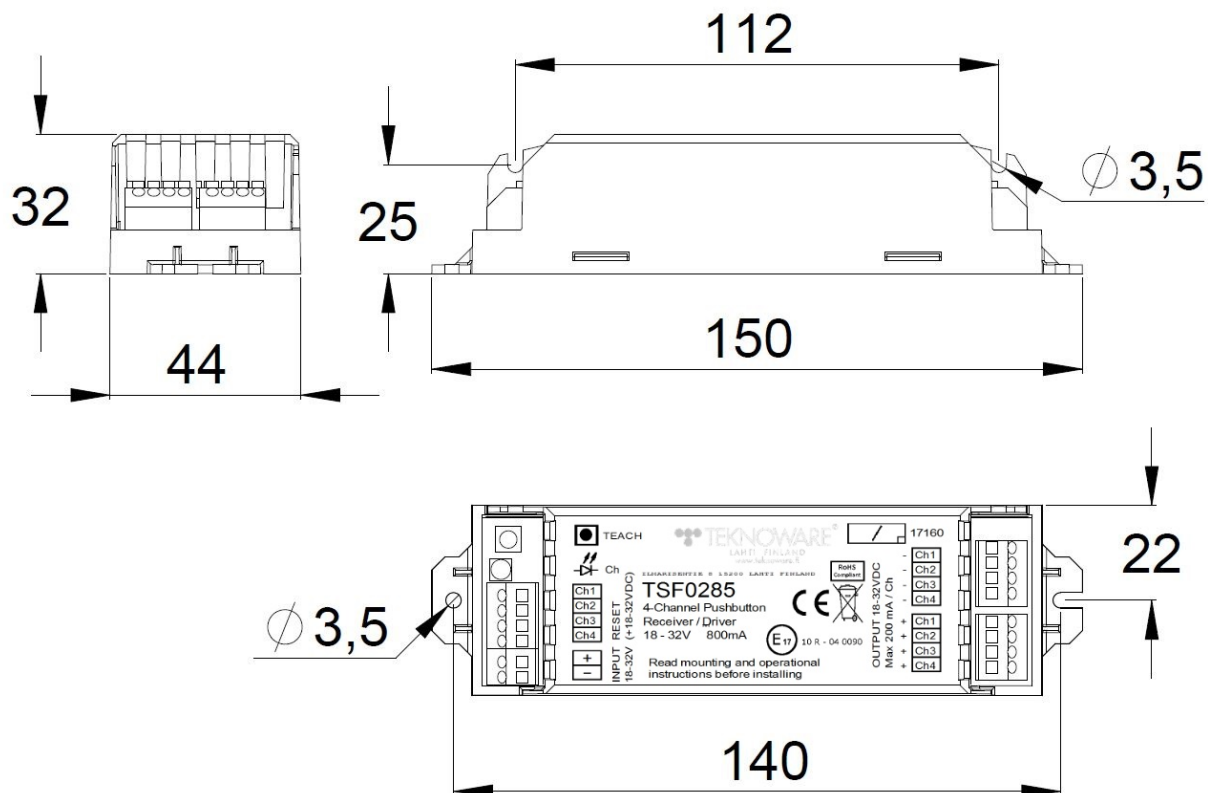

Figure 10. Dimensions of the receivers

5 DOCUMENT INFORMATION

Project: General	Customer: General	Customer document reference:
Prepared by: Inkeri Hyvönen	Checked by: Sonja Kuusanmaa	Approved by: <i>AKo</i>
Revision: 3	Pages: 19	Date: 24.5.2021

Revision follow-up

Revision:	Purpose:	Date:	Author:
0	Completely renewed document to new template	11.8.2020	Ella Hasa
1	Updated programming instructions for product versions 1 and 2.	4.2.2021	Inkeri Hyvönen
2	Added information about cleaning (ch. 1.3) and max. torque for stop buttons (ch. 4.1).	15.3.2021	Inkeri Hyvönen
3	Corrected information about TSF0287 in ch. 1.1.1.	24.5.2021	Inkeri Hyvönen



Teknoware Oy

Ilmarisentie 8, FI-15200 Lahti, Finland

Tel: +358 883 020

teknoware.com

documentation@teknoware.com

The undersigned, representing the following manufacturer

Name: Teknoware Oy
Address: Ilmarisentie 8, FIN-15200 Lahti, Finland
Tel: +358 (0)3 883 020
Fax: +358 (0)3 8830 240

herewith declares that the product

Type of equipment: Wireless push button
Model: TSF0290, TSF0290B, TSF0291, TSF0291B, TSF0292, TSF0292B, TSF0293, TSF0293B, TSF0294, TSF0294B, TSF0295, TSF0295B, TSF0300, TSF0301, TSF0302, TSF0303, TSF0304, TSF0305, TSF0306, TSF0307, TSF0308, TSF0309, TSF0310, TSF0311, TSF0312, TSF0313, TSF0314, TSF0315, TSF0316, TSF0317, TSF0318, TSF0319, TSF0320, TSF0321, TSF0322, TSF0323

is in conformity with the provisions of the following EC directive(s)

Reference No.	Title
2014/53/EU	RED - Radio Equipment Directive
2012/19/EU	WEEE - Waste Electrical and Electronic Equipment
2011/65/EU	RoHS - Restriction of Hazardous Substances

and that the standards referenced below have been applied.

Place: Lahti

Date: 13.8.13

Signature: 
Kai Kauto
Managing Director

References of harmonized standards applied for this EC declaration of conformity:

No.	Subject
EN 301489-3: V1.6.1	Electromagnetic compatibility and Radio spectrum Matters (ERM); ElectroMagnetic Compatibility (EMC) standard for radio equipment and services; Part 3: Specific conditions for Short-Range Devices (SRD) operating on frequencies between 9 kHz and 246 GHz
EN 61000-6-1	Electromagnetic compatibility-Generic immunity standard
EN 61000-4-3	Radiated, radio-frequency, electromagnetic field immunity test
ISO7637	Road vehicles - Electrical disturbances from conduction and coupling
EN 300220-2: V3.1.1	Short Range Devices (SRD) operating in the frequency range 25 MHz to 1 000 MHz; Part 1: Technical characteristics and methods of measurement
EN 60950-1:2006+A2:2013	Information technology equipment - Safety Part 1: General

Other references/information, if required by the EC directive(s):

The undersigned, representing the following manufacturer

Name: Teknoware Oy
Address: Ilmarisentie 8, FIN-15200 Lahti, Finland
Tel: +358 (0)3 883 020
Fax: +358 (0)3 8830 240

herewith declares that the product

Type of equipment: Receiver for wireless push buttons
Model: TSF0285, TSF286, TSF0275, TSF0276

is in conformity with the provisions of the following EC directive(s)

Reference No.	Title
2014/53/EU	RED - Radio Equipment Directive
2012/19/EU	WEEE - Waste Electrical and Electronic Equipment
2011/65/EU	RoHS - Restriction of Hazardous Substances

and that the standards referenced below have been applied.

Place: Lahti

Date: 13.8.19

Signature: 

Kai Kauto
Managing Director

References of harmonized standards applied for this EC declaration of conformity:

No.	Subject
EN 301489-3: V1.6.1	Electromagnetic compatibility and Radio spectrum Matters (ERM); ElectroMagnetic Compatibility (EMC) standard for radio equipment and services; Part 3: Specific conditions for Short-Range Devices (SRD) operating on frequencies between 9 kHz and 246 GHz
EN 61000-6-1	Electromagnetic compatibility-Generic immunity standard
EN 61000-4-3	Radiated, radio-frequency, electromagnetic field immunity test
ISO7637	Road vehicles - Electrical disturbances from conduction and coupling
EN 300220-2: V3.1.1	Short Range Devices (SRD) operating in the frequency range 25 MHz to 1 000 MHz; Part 1: Technical characteristics and methods of measurement
EN 60950-1:2006+A2:2013	Information technology equipment - Safety Part 1: General requirements

Other references/information, if required by the EC directive(s):